

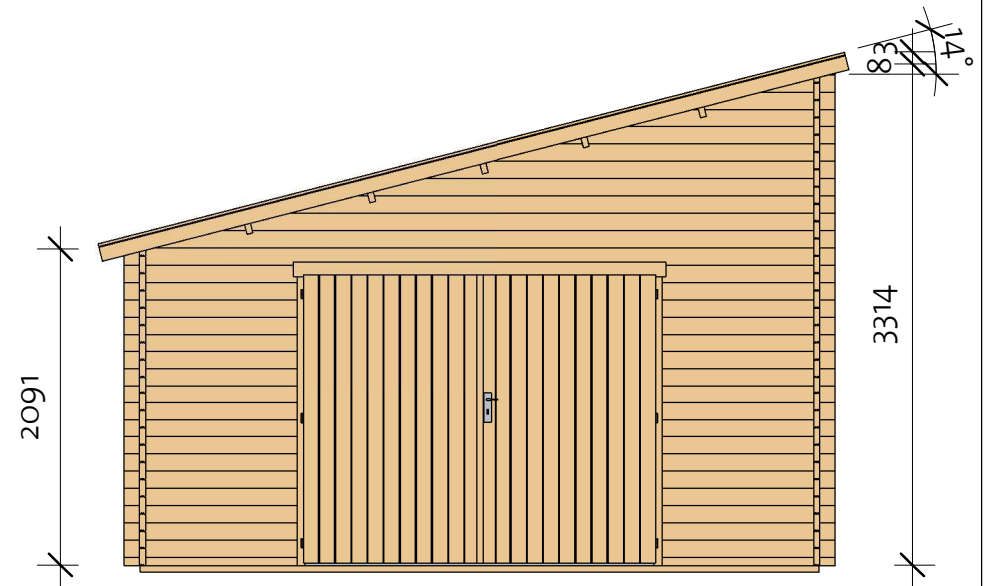

c.Svea I 40 (450x550)

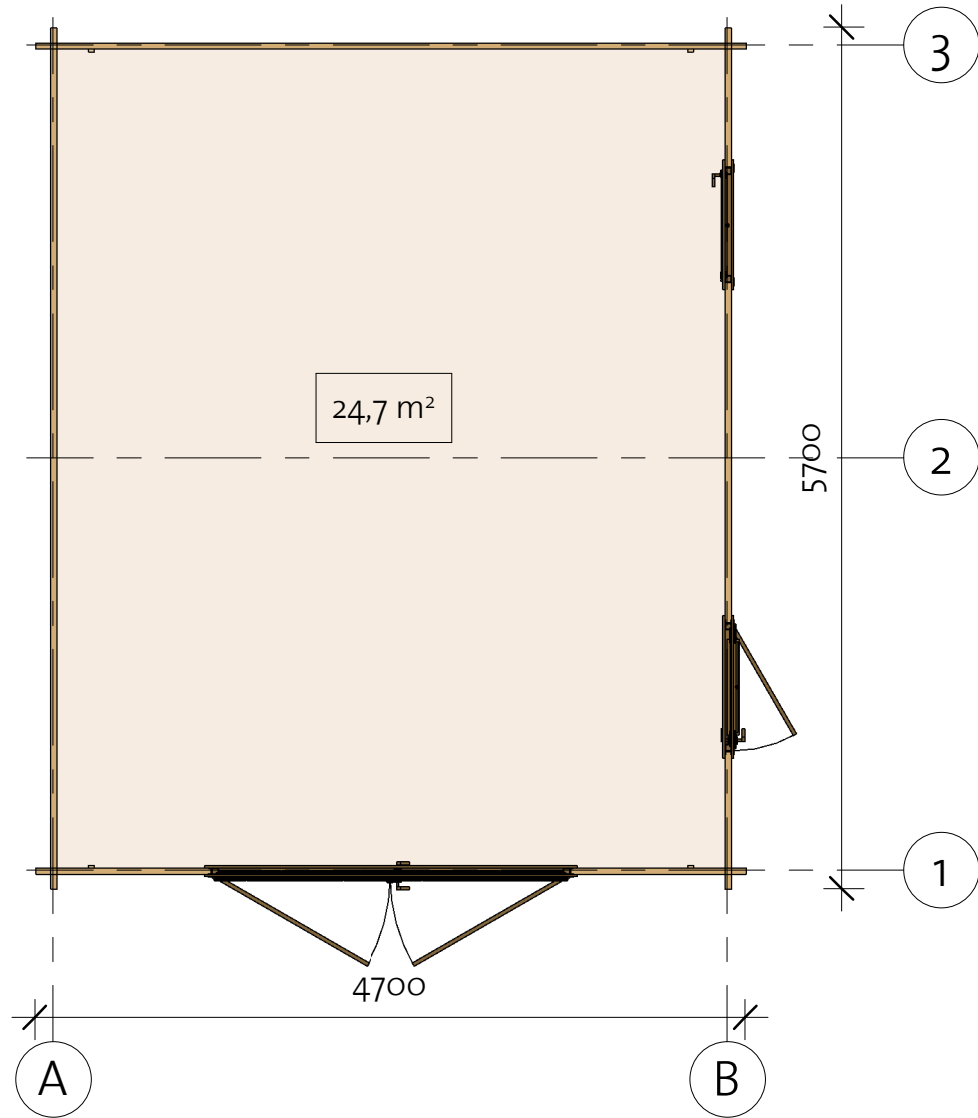
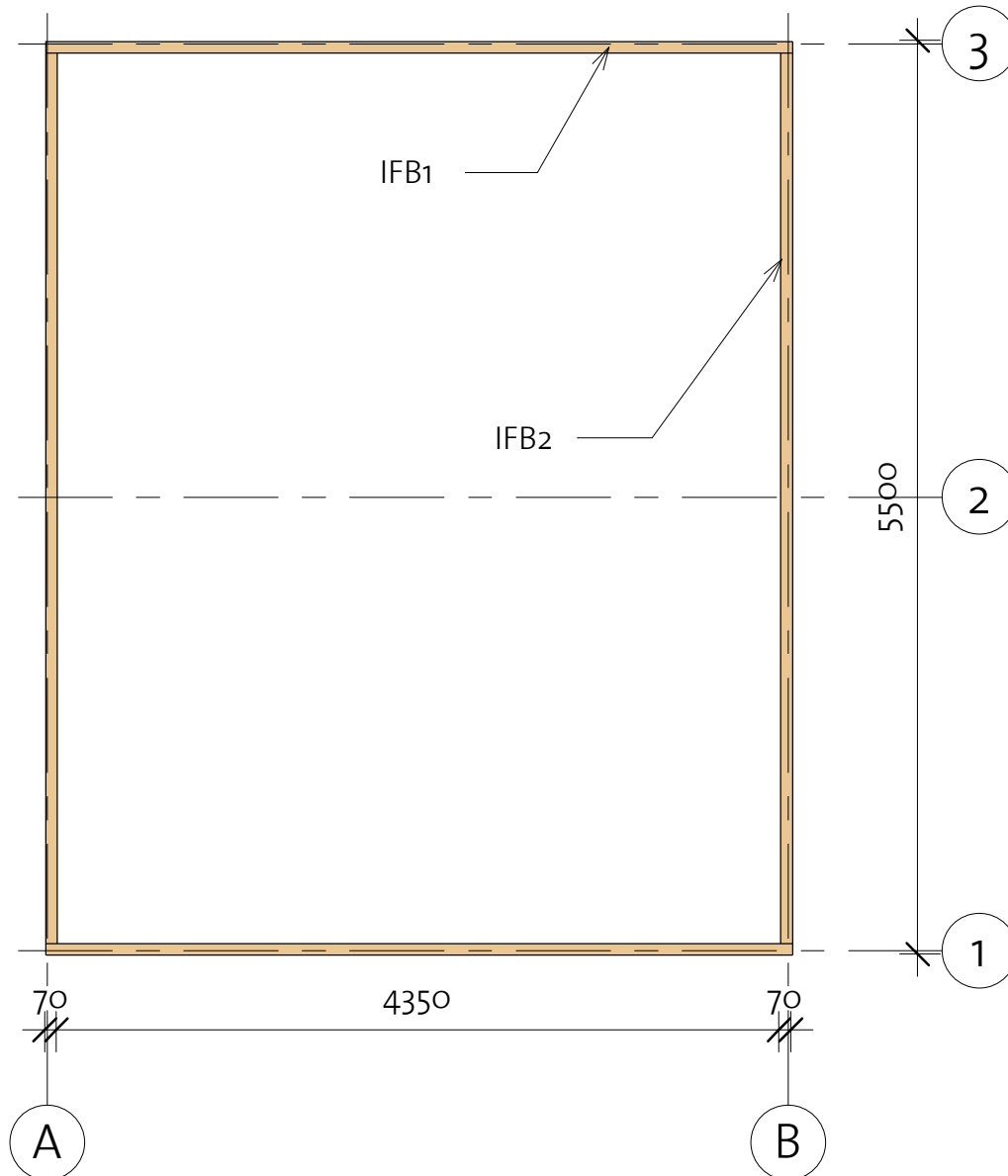

c.Svea I 40 (450x550)

Foundation



Impregnated foundation beams				
Mark	Type	Profile	Count	Length
IFB1	IFB 70x40		2	4490
IFB2	IFB 70x40		2	5360

c.Svea I 40 (450x550)

Wall 1

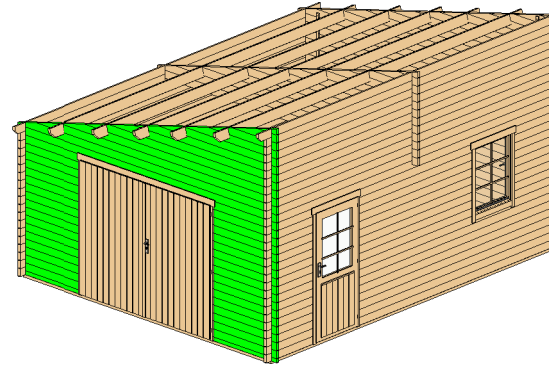

Log Profile Wall 1	
Profile	Profile

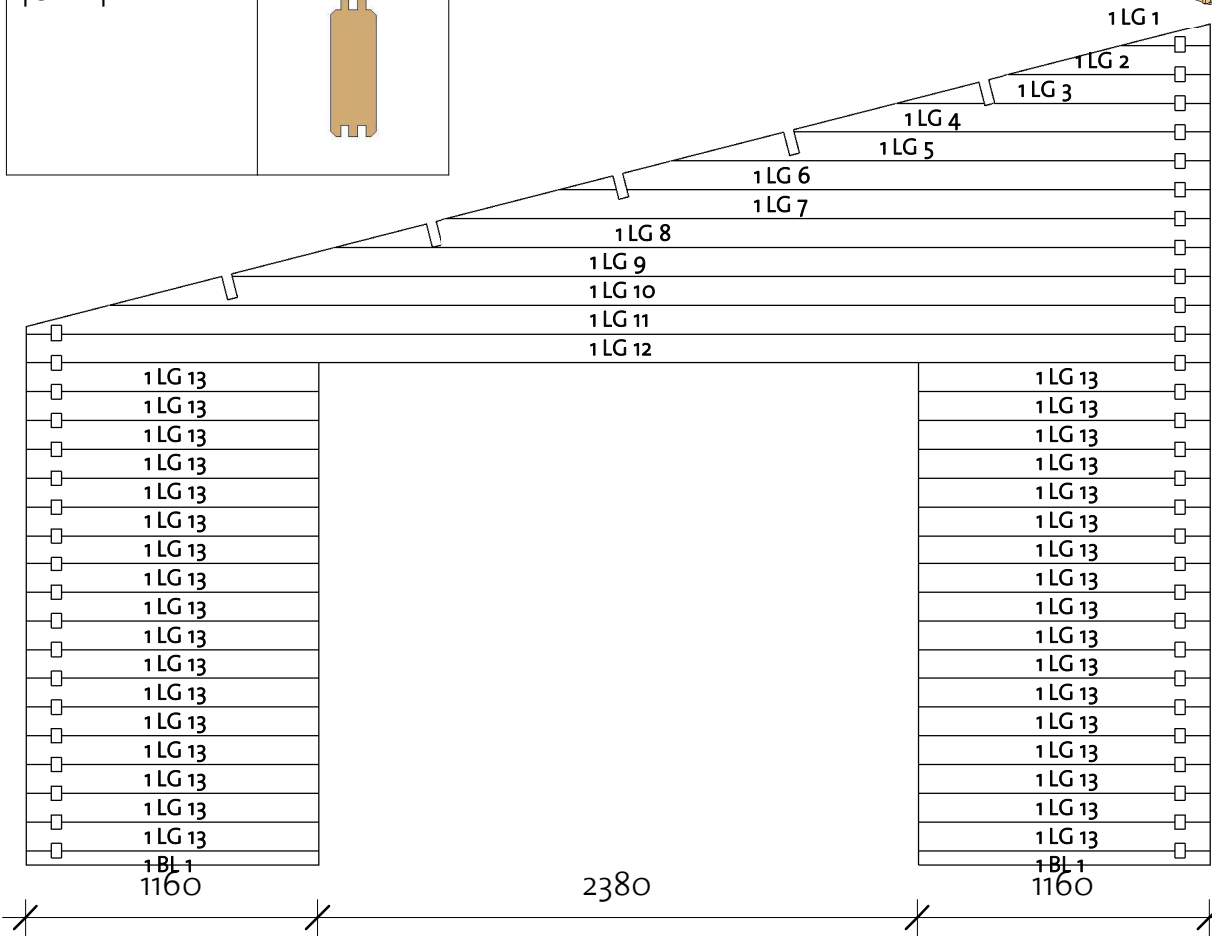
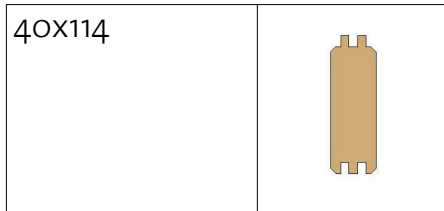

Wall 1			
Mark	Profile	Count	Cut Length

1BL 1	40X57	2	1160
1LG 1*	40X114	1	354
1LG 2*	40X114	1	800
1LG 3*	40X114	1	1246
1LG 4*	40X114	1	1656
1LG 5*	40X114	1	2138
1LG 6*	40X114	1	2584
1LG 7*	40X114	1	3030
1LG 8*	40X114	1	3476
1LG 9*	40X114	1	3886
1LG 10*	40X114	1	4368
1LG 11*	40X114	1	4700
1LG 12	40X114	1	4700
1LG 13	40X114	34	1160

* Gable - delivered premounted

Log Profile Wall 1	
Profile	Profile

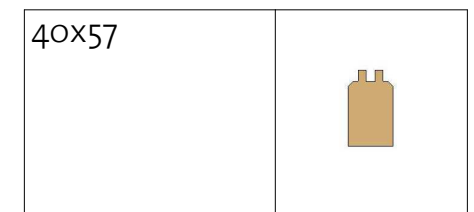

c.Svea I 40 (450x550)

Wall 2

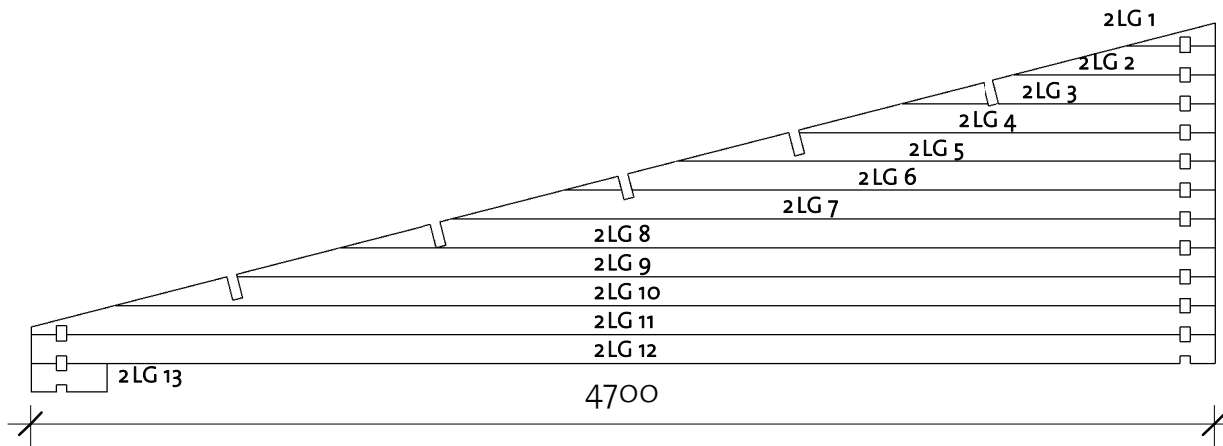
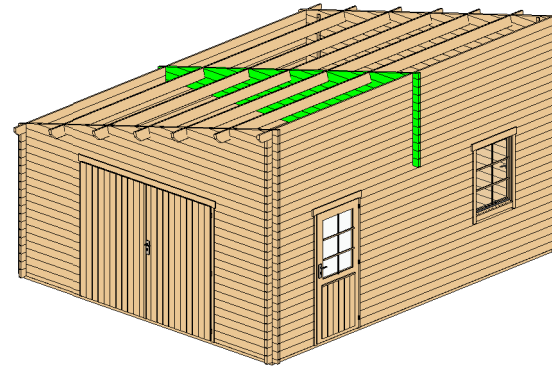

Wall 2			
Mark	Profile	Count	Cut Length

2LG 1*	40X114	1	354
2LG 2*	40X114	1	800
2LG 3*	40X114	1	1246
2LG 4*	40X114	1	1656
2LG 5*	40X114	1	2138
2LG 6*	40X114	1	2584
2LG 7*	40X114	1	3030
2LG 8*	40X114	1	3476
2LG 9*	40X114	1	3886
2LG 10*	40X114	1	4368
2LG 11*	40X114	1	4700
2LG 12	40X114	1	4700
2LG 13	40X114	1	300

* Gable - delivered premounted

Log Profile Wall 2	
Profile	Profile

40X114	
--------	--

c.Svea I 40 (450x550)

Wall 3

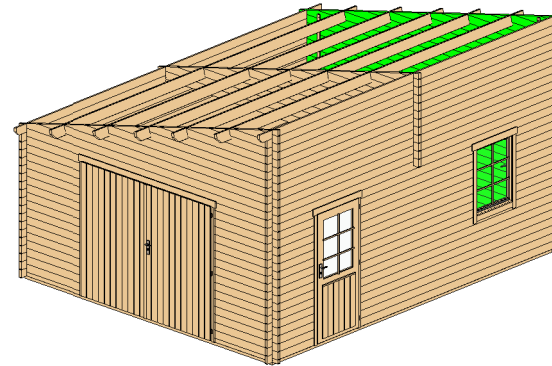

Log Profile Wall 3	
Profile	Profile

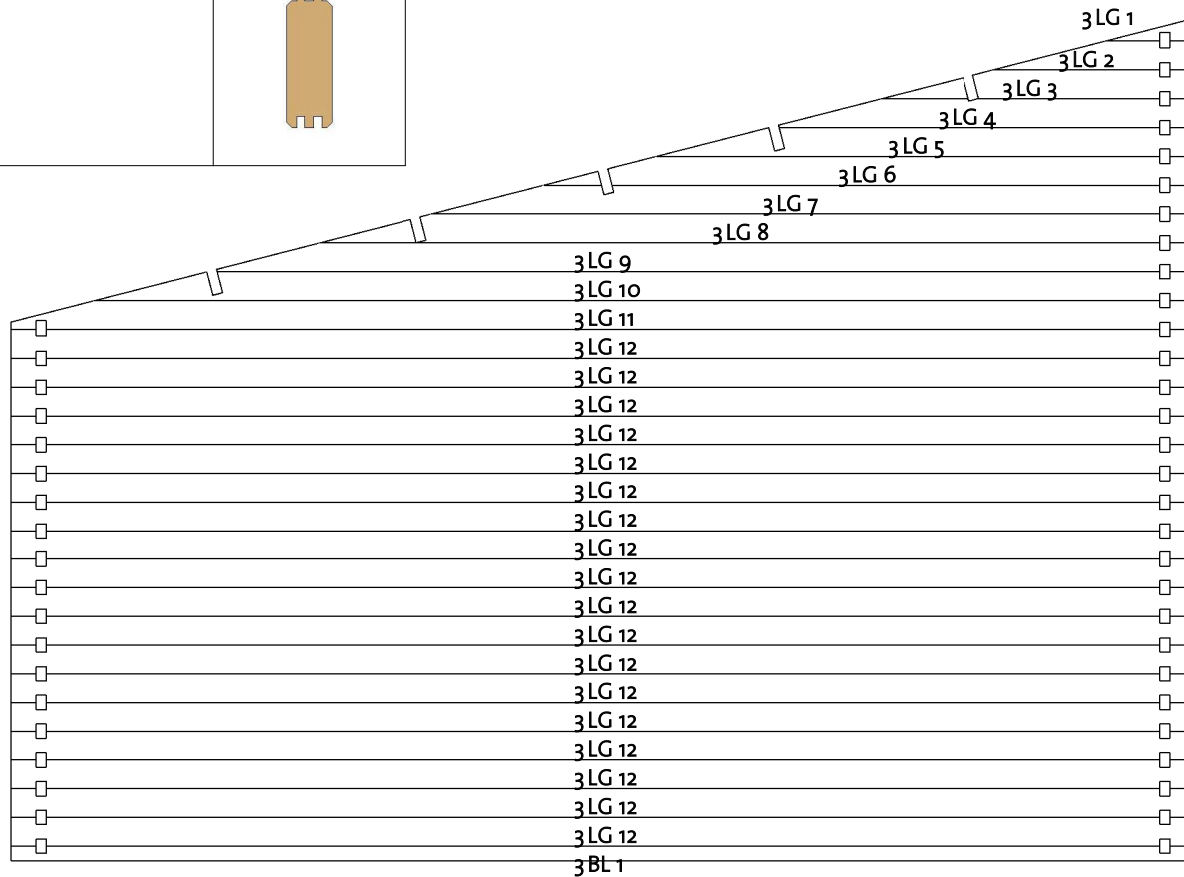
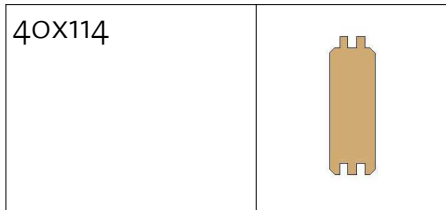

Wall 3			
Mark	Profile	Count	Cut Length

3BL 1	40X57	1	4700
3LG 1 *	40X114	1	354
3LG 2 *	40X114	1	800
3LG 3 *	40X114	1	1246
3LG 4 *	40X114	1	1656
3LG 5 *	40X114	1	2138
3LG 6 *	40X114	1	2584
3LG 7 *	40X114	1	3030
3LG 8 *	40X114	1	3476
3LG 9 *	40X114	1	3886
3LG 10 *	40X114	1	4368
3LG 11 *	40X114	1	4700
3LG 12	40X114	18	4700

* Gable - delivered premounted

Log Profile Wall 3	
Profile	Profile

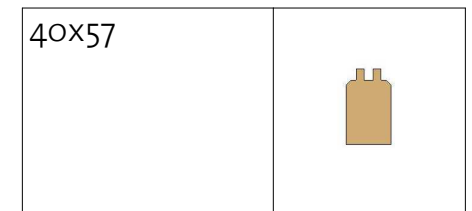

c.Svea I 40 (450x550)

Wall A

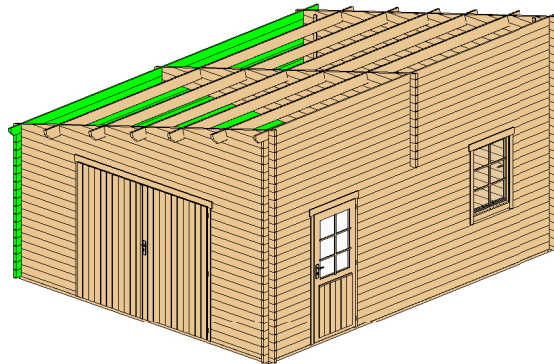

Wall A			
Mark	Profile	Count	Cut Length

ALG 1	40x114	17	5700
ALG 2	40x114	1	5700
ATL 1	40x122	1	5950

Log Profile Wall A	
Profile	Profile

40x114	
40x122	

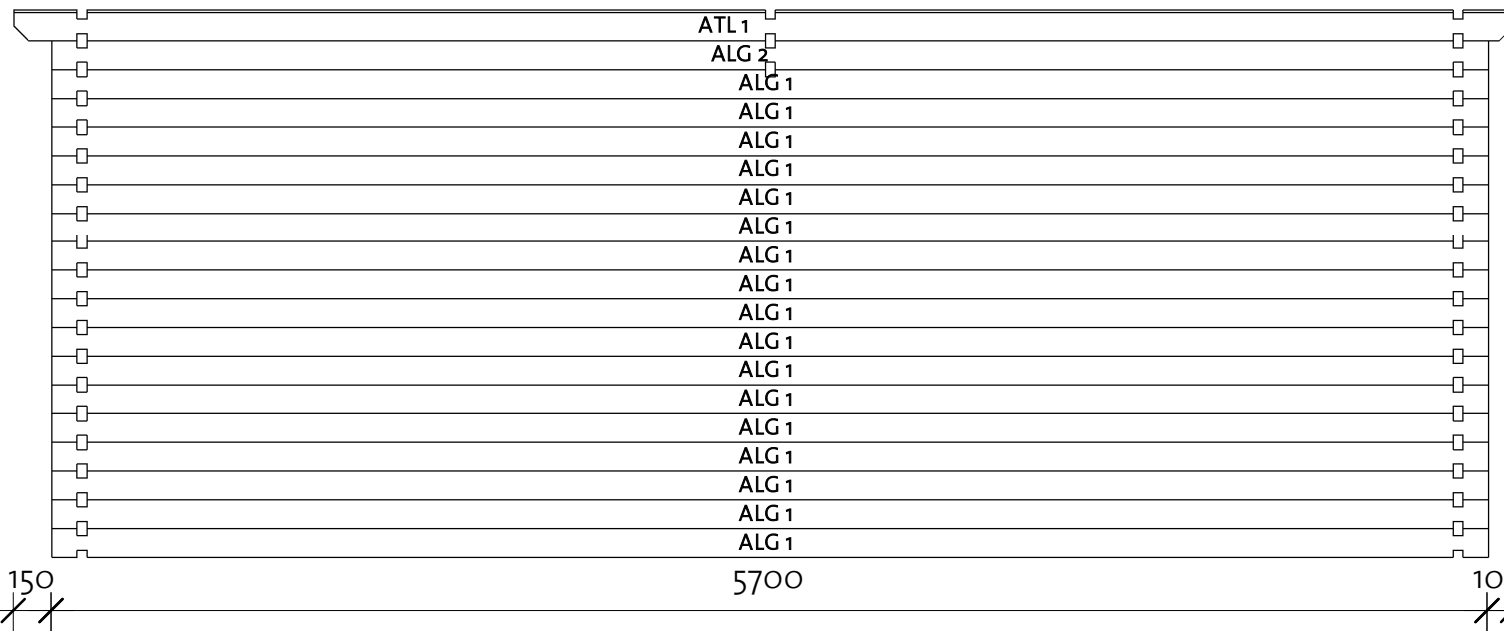

c.Svea I 40 (450x550)

Wall B

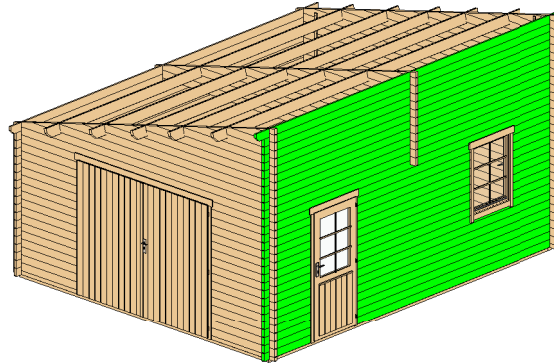

Wall B			
Mark	Profile	Count	Cut Length

BLG 1	40x114	8	3930
BLG 2	40x114	26	920
BLG 3	40x114	9	2240
BLG 4	40x114	11	5700
BTL 1	40x122	1	5950

Log Profile Wall B	
Profile	Profile

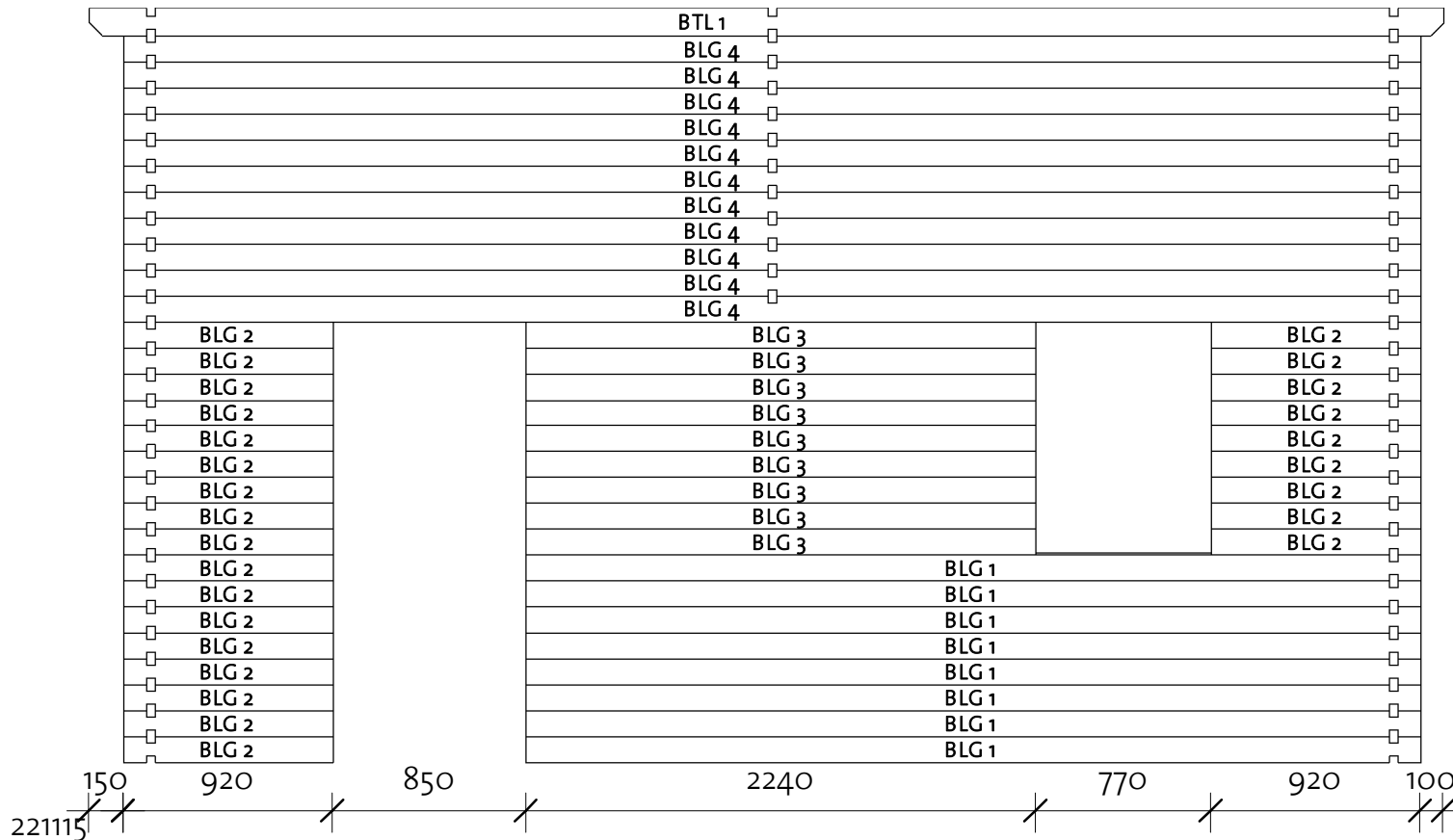

40x114	
40x122	

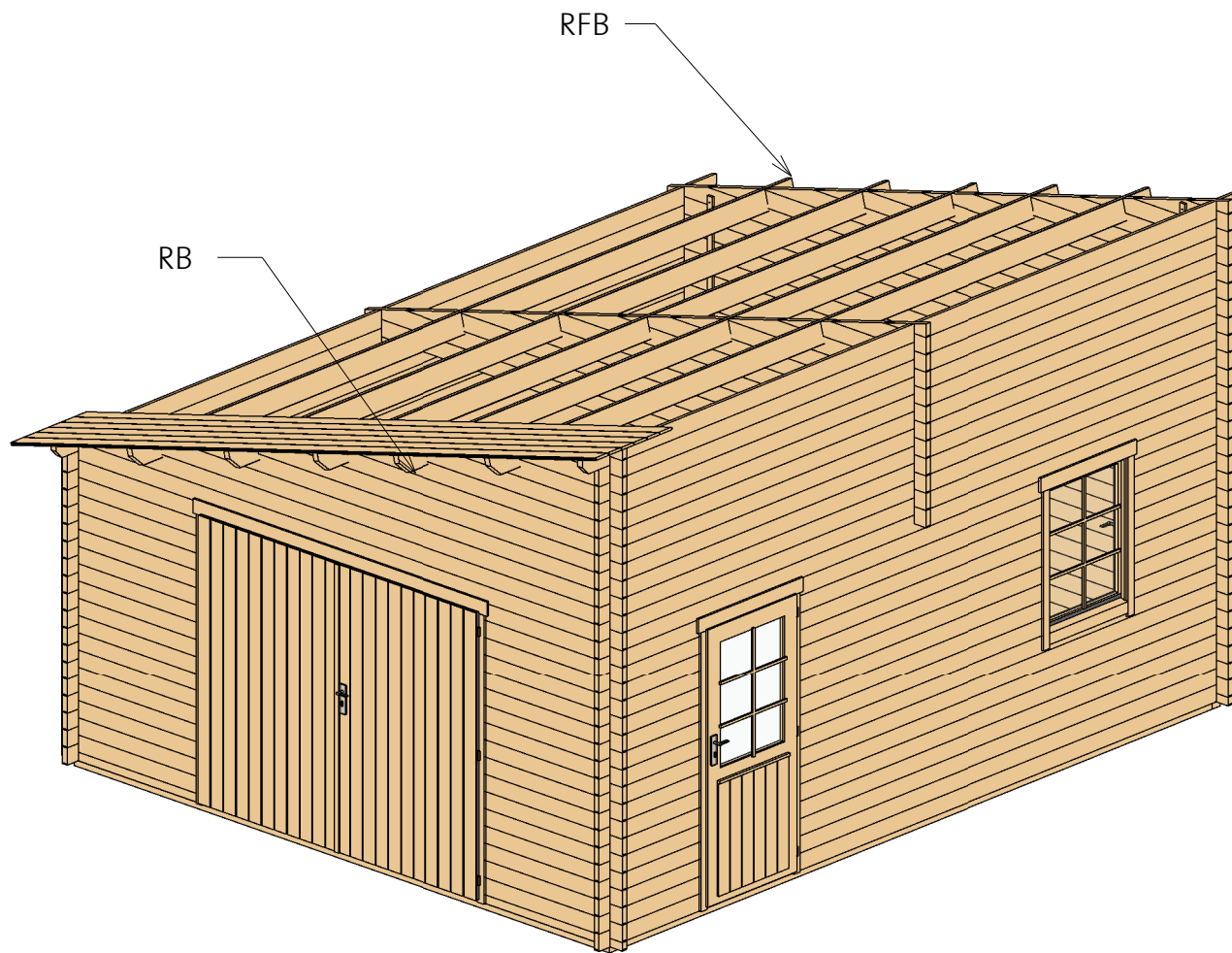

c.Svea I 40 (450x550)

Roof 1



Roof				
Mark	Type	Profile	Count	Length
RFB	Beam 40x143		5	5950
RB	17x114		53	5058

c.Svea I 40 (450x550)

Roof 2

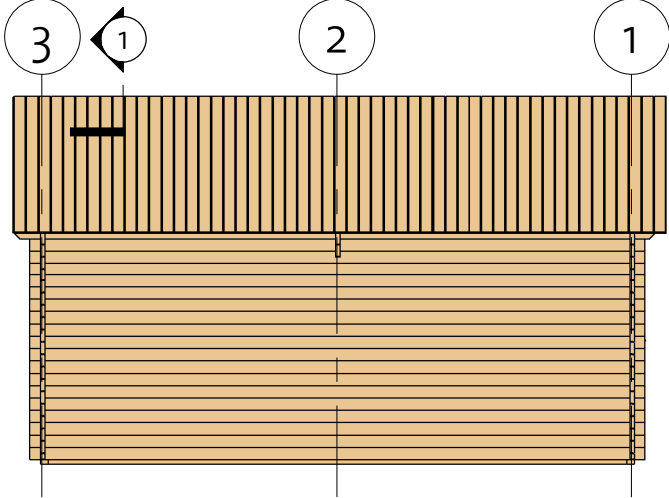

① Roof Reinforcement 1

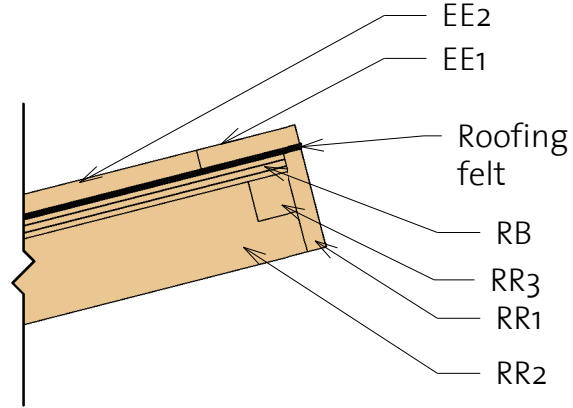

② Roof Reinforcement 2

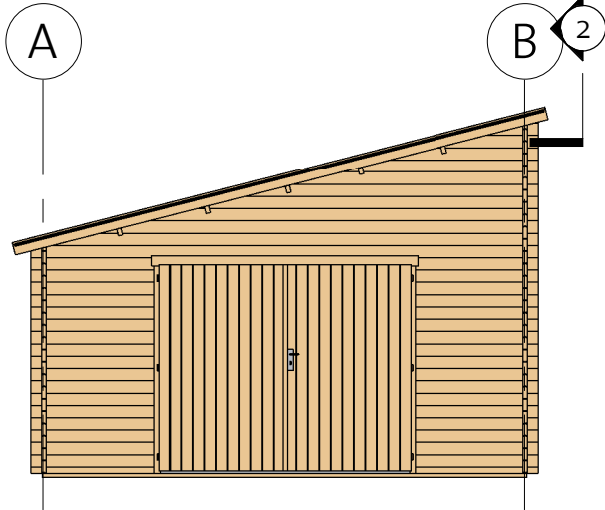
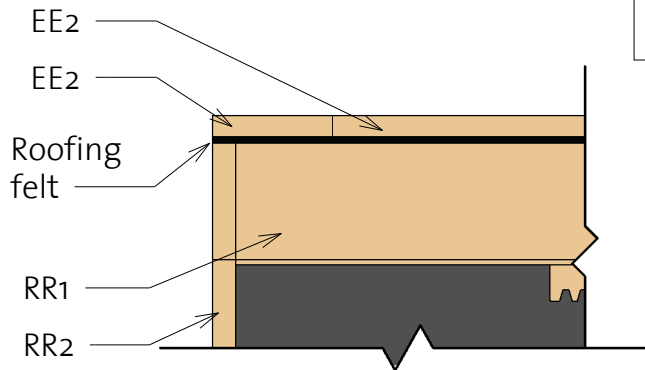

Fascia Schedule				
Mark	Type	Profile	Count	Length
EE1	Eave Edging 18x95		1	5796
EE2	Eave Edging 18x95		2	5094
RR1	Roof reinforcement 18x95		2	5950
RR2	Roof reinforcement 18x95		2	5094
RR3	Roof reinforcement 38x38		2	5950

c.Svea I 40 (450x550)

Extras

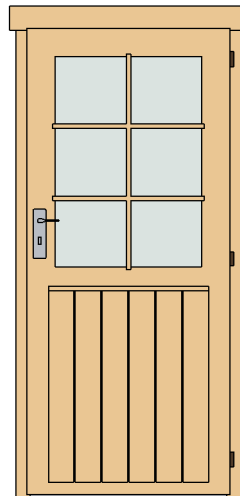
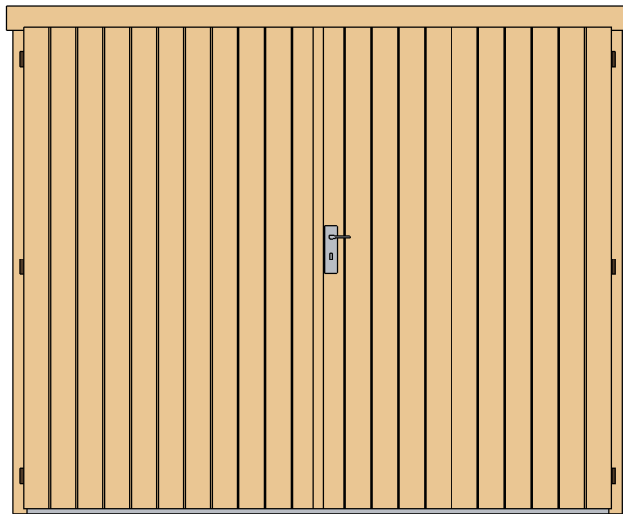

Door Schedule				
Mark	Type	Width	Height	Count
CD1R	Classic door 1 right	840	1890	1
CDD10R	Classic double door 10, wood right	2370	1955	1
DCB6	Door Crossbar 6	--	--	1

Fasteners/Extras		
Name	Type	Count

Hitblock	300-400 mm	
Door Bolt	315 x 65	2
Bolts	M8 x 70	12
Screws	5,0 x 70	15
Screws	5,0 x 40	16
Screws	6,0 x 140	60
Screws	4,0 x 40	590

Type	Count	Length
------	-------	--------

Windboard	2	2200
Windboard	2	3200

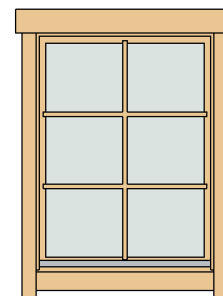



Window Schedule				
Mark	Type	Width	Height	Count
CW1R	Classic window 1 right	765	990	1
WCB6	Window Crossbar 6	--	--	1



c.Svea I 40 (450x550)

List of all items 1



Impregnated foundation beams				
Mark	Type	Profile	Count	Length

IFB1	IFB 70x40		2	4490
IFB2	IFB 70x40		2	5360

Roof				
Mark	Type	Profile	Count	Length

RFB	Beam 40x143		5	5950
RB	17x114		53	5058

Fascia Schedule				
Mark	Type	Profile	Count	Length

EE1	Eave Edging 18x95		1	5796
EE2	Eave Edging 18x95		2	5094
RR1	Roof reinforcement 18x95		2	5950
RR2	Roof reinforcement 18x95		2	5094
RR3	Roof reinforcement 38x38		2	5950

c.Svea I 40 (450x550)

List of all items 2

Wall 1			
Mark	Profile	Count	Cut Length

1BL 1	40X57	2	1160
1LG 1 *	40X114	1	354
1LG 2 *	40X114	1	800
1LG 3 *	40X114	1	1246
1LG 4 *	40X114	1	1656
1LG 5 *	40X114	1	2138
1LG 6 *	40X114	1	2584
1LG 7 *	40X114	1	3030
1LG 8 *	40X114	1	3476
1LG 9 *	40X114	1	3886
1LG 10 *	40X114	1	4368
1LG 11 *	40X114	1	4700
1LG 12	40X114	1	4700
1LG 13	40X114	34	1160

Wall 3			
Mark	Profile	Count	Cut Length

3BL 1	40X57	1	4700
3LG 1 *	40X114	1	354
3LG 2 *	40X114	1	800
3LG 3 *	40X114	1	1246
3LG 4 *	40X114	1	1656
3LG 5 *	40X114	1	2138
3LG 6 *	40X114	1	2584
3LG 7 *	40X114	1	3030
3LG 8 *	40X114	1	3476
3LG 9 *	40X114	1	3886
3LG 10 *	40X114	1	4368
3LG 11 *	40X114	1	4700
3LG 12	40X114	18	4700

Wall 2			
Mark	Profile	Count	Cut Length

2LG 1*	40X114	1	354
2LG 2*	40X114	1	800
2LG 3*	40X114	1	1246
2LG 4*	40X114	1	1656
2LG 5*	40X114	1	2138
2LG 6*	40X114	1	2584
2LG 7*	40X114	1	3030
2LG 8*	40X114	1	3476
2LG 9*	40X114	1	3886
2LG 10*	40X114	1	4368
2LG 11*	40X114	1	4700
2LG 12	40X114	1	4700
2LG 13	40X114	1	300

Wall A			
Mark	Profile	Count	Cut Length

ALG 1	40X114	17	5700
ALG 2	40X114	1	5700
ATL 1	40X122	1	5950

Wall B			
Mark	Profile	Count	Cut Length



BLG 1	40X114	8	3930
BLG 2	40X114	26	920
BLG 3	40X114	9	2240
BLG 4	40X114	11	5700
BTL 1	40X122	1	5950

*Gable-delivered premounted

c.Svea I 40 (450x550)

List of all items 3

Log Profiles	
Profile	Profile

40X57	
40X114	

Log Profiles	
Profile	Profile

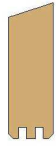
40X122	
--------	--